

RED CABOOSE

HO Scale

PARTS LIST:

Part #	Part Description	On Sprue #	Quantity
1.	Body		1
2.	Weight		1
3.	Floor Insert		1
4.	Door mechanism rods	1	2
5.	Sub frame	2	1
6.	Main frame		1
7.	Air line	1	1
8.	Brake lever & rods	1	1
9.	A end	3	1
10.	End grab	2	2
11.	End ladder	5	2
12.	B end	3	1
13.	Retainer & pipe	5	1
14.	Brake mechanism, rod & chain	5	1
15.	Brake wheel	6	1
16.	Brake platform brackets	5	2
17.	Brake platform	5	1
18.	End body grab	2	4
19.	End rod mechanism ratchet handle	6	4
20.	Side mechanism cover	6	4
21.	Composite side, side ladder	5	2
22.	Composite side grabs	2	4
23.	Corner caps	6	4
24.	Coupler		2
25.	Coupler box cover	2	2
26.	Coupler screw 1/8 "		2
27.	Brake fulcrum & chain	5	1
28.	Air hose	4	2
29.	Cut lever bracket	6	2
30.	Coupler lift bar (metal)		1
31.	Stirrup steps	2	4
32.	Brake reservoir	4	1
33.	Triple valve	4	1
33a.	Triple valve bracket	2	1
34.	Brake cylinder	4	1
34a.	Brake cylinder bracket	2	1
35.	Truck side frames		4
36.	Bolsters		2
37.	Wheels		4
38.	Truck screw 1/4"		2

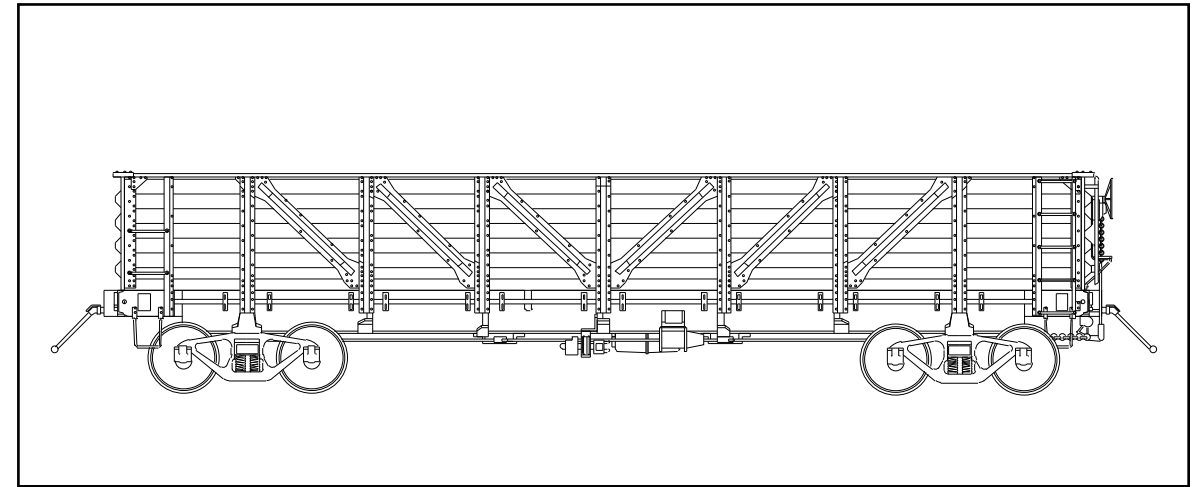

G-50-23

Composite Side Drop Bottom Gondola

HISTORY

Railroading, like other industries, has continually changed as processes, needs and ideas have evolved. Drop bottom gondolas evolved as well. In the early years, dirt, gravel and other commodities were shoveled onto and off of flat cars. It was realized early that much of the shoveled on load was lost as the car was moved and the carried load shifted and slid off. Solution, adding sides which brought the first gondola. It was also learned that if the sides were removed, the load could be unloaded easier. This idea evolved into cars with side doors. At about the same time, it was also realized that if doors were added to the bottom of the car the load could be unloaded or "dropped" even faster.

Numerous designs for many uses were designed by both standard gauge and narrow gauge railroads. Wood construction was the norm in the early years. Composite construction (wood, steel or iron) followed, and was used for many years thereafter and even though replaced by all steel construction in later years, some cars were built to composite standards in later years to conserve weight or materials due to economics, war or commodities carried.

Gondola's are multi purpose cars, even those with drop doors were used to carry logs, lumber, machinery, scrap etc.. Their main designed purpose was to carry product such as dirt, gravel, minerals, waste, sugar beets and other materials that would flow through the bottom doors when opened for ease of unloading.

This model is of a Southern Pacific G-50-23 composite side gon built in 1949. Also available is the Southern Pacific G-50-22 steel side gondola and the Union Pacific G-50-13.

RED CABOOSE

P.O. Box 250 • Mead, CO 80542
www.red-caboose.com • e-mail: stacktalk@aol.com
December 1999

Each part is guaranteed* against factory defect or breakage. If you get glue on or break a part, this is also covered under the guarantee* as well as parts missing from the kit. It is the intention of Red Caboose to make sure the product you purchased is operating on your railroad the way you intended, instead of the shelf, not able to be completed because of a part. When contacting Red Caboose, always include; scale, road name, kit number & part number.

*Some parts may not always be available because of discontinuance of the product or the road name or the color may be out of production. Every attempt will be made to replace your part.

Helpful Hints:

Water base paint is used on decorated cars, this acts like a protective glove when trying to glue parts together. Parts fit best when mounting holes are drilled and mounting pins and other mounting surfaces are scraped so that solvent base glues attack the plastic forming a solid bond.

Helpful Tools:

Hobby Knife	Sharp blades	Small Philips screwdriver	Small needle nose pliers	Tweezers
Pin Vise	#76 drill	#79 drill	#60 drill for brake cylinder	#69 drill for triple valve

Most Recommended Tool - PBL-804 Nippers (Tweezers that cut)

Sold by: *PBL, P.O. Box 769 Ukiah, CA 95482 (Phone: 707-462-7680)*

Assembly:

Please note that most parts have been silhouetted for easy identification and/or shown in the exploded view. Part numbers follow logical assembly sequence (with the most vulnerable to be added last).

Please read the instructions thoroughly before starting!

Gondola Body & Underframe:

Note the body, part 1, has a cavity inside, test fit the weight, part 2, into this cavity. For best fit, make sure the weight is perfectly straight. Test fit the floor, part 3, over the weight and make sure the floor fits tight. Adjust as necessary for a good fit and glue the weight and floor in place.

Turn the body over. From sprue 1, cut the 2 door mechanism rods, part 4, and glue in place along the sides of the underbody as shown in the bottom view drawing, the small tabs should touch the doors. Because these parts are long and can curve unevenly, start gluing from the center and work out slowly letting each joint dry to keep the part straight.

Cut from sprue 2, part 5, the sub frame, and part 6, the main frame and be sure that all sprue material on the ends of the crossbearers and bolsters is trimmed off so that you will have a clean fit between the exterior post when glued in place. (If you don't the frame will not fit correctly and the frame will bow and/or the car will sit crooked.) Glue part 5 and part 6 together making sure the cast in letter B is at the same end. From sprue 2, cut the brake cylinder bracket, part 34a, and glue to the frame between the two small bosses on the frame flange. Glue the airline in place, part 7 on sprue 1, making sure both ends reach out to the bolsters. Glue the frame to the body with the "B" pointed towards the end that has two mounting post on it.

Note which end has the two mounting post as this will now be referred to as the "B" end of the car.

Glue in place the brake levers and rods, part 8 on sprue 1.

Do not glue any other brake detail on the car body at this time, it is to delicate.

Ends: - Do not glue into place either the A or B end when done.

Locate the "A" end, part 9 on sprue 3, and cut from sprue. Glue the end grab iron, part 10 on sprue 2, in place. Glue the end ladder, part 11 on sprue 5, and glue in place. Set aside to dry, do not glue in place yet.

From sprue 3, cut the "B" end, part 12, and glue parts 10 and 11 in place as you did on part 9, the "A" end. From

sprue 5, cut the retainer & pipe, part 13, and glue in place as shown. Also from sprue 5, cut the brake mechanism, part 14, and brake wheel, part 15, and glue the wheel into the mechanism. When dry, glue the assembly to the "B" end as shown. From sprue 5 cut the brake platform brackets, part 16, and glue in place as shown. Also from sprue 5, cut the brake platform, part 17, and glue on top of the brackets as shown. The "B" end is done, but do not glue in place.

Body Ends and Side Detail:

From sprue 2, cut 4 end body grab irons, part 18, and glue in place as shown on each end. From sprue 6, cut 4 end rod mechanism handles, part 19, and glue in place on each end. Position part 19 so that the rounded edge points up and in towards the center of the car end (see exploded view).

From sprue 6, cut 4 side mechanism covers, part 20, and glue in place as shown. From sprue 5, cut 2 side ladders, part 21, and glue in place as shown. From sprue 2, cut 4 side corner grab irons, part 22, and glue in place as shown.

Glue the "A" & "B" ends into place.

From sprue 6, cut 4 end caps, part 23, and glue in place on the four corners as shown.

Couplers:

Supplied with this kit are either Accurail Accumate* (some assembly required, see inset on drawing page) or McHenry* couplers (both are part 24). Place the assembled coupler in the coupler box and cover with coupler box cover, part 25 on sprue 2, and secure with the 1/8" screw, part 26.

Final Detail:

From sprue 5, cut the brake fulcrum & chain, part 27, and glue in place on the bottom as shown. From sprue 4, cut two air hoses, part 28, and glue in place alongside the coupler box as shown. From sprue 6, cut two coupler lift bar brackets, part 29, and gently slip the metal coupler lift bar, part 30, through the hole in the bracket. Glue the assembly on the bottom at each end in the mounting hole as shown. Once in place, angle the rod under the coupler (just below and not touching so coupler can swing) and glue the rod into a stationery position by gluing it at the bracket. From sprue 2, cut four stirrup steps, part 31, and glue in place on the sides as shown.

Brake Detail:

From sprue 4, cut the brake reservoir, part 32. Glue in place on the crossbearer and frame brackets as shown on the inset drawing with air line holes pointing towards the frame. From sprue 4, cut the triple valve, part 33, and from sprue 2, cut the triple valve bracket, part 33a. See inset drawing and glue the bracket to the triple valve and glue in place in the hole on the crossbearer with pipe holes pointing towards frame. From sprue 4, cut the brake cylinder, part 34. See inset drawing and cut the bottom (pin side) portion of the clevis off. Glue to the brake cylinder bracket as shown on the inset drawing.

Trucks:

Assemble the trucks by snapping the sideframes, part 35, into the bolster, part 36 (unless full frame Bettendorf trucks are used). Then insert the wheels, part 37, into the sideframes. Install the completed trucks using 1/4" screw, part 38.

*Accurail & Accumate are registered trade names and are used with permission.

*McHenry is a registered trade name and is used with permission.

This completes your model. It is hoped that you will enjoy this car for years to come!
Remember, don't let a missing, broken or ruined part keep you from completing and operating your model.
Contact us immediately to take full advantage of the guarantee if needed.

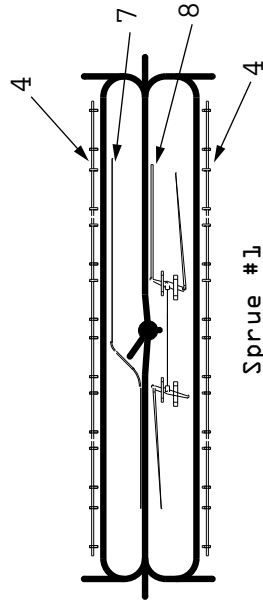
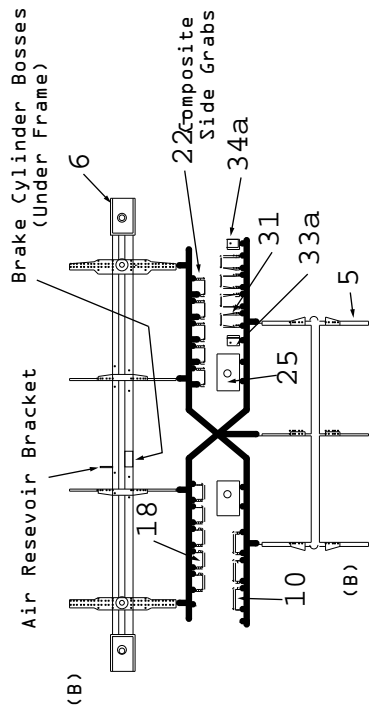

Sprue #1

Sprue #2

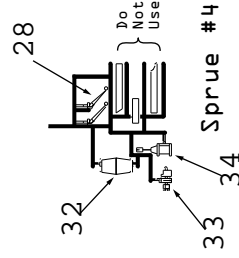
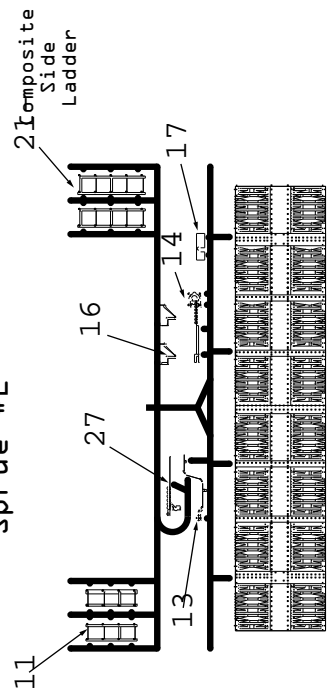

Sprue #3

Sprue #4

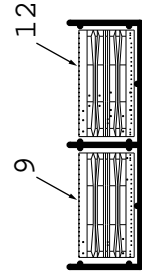

Sprue #5

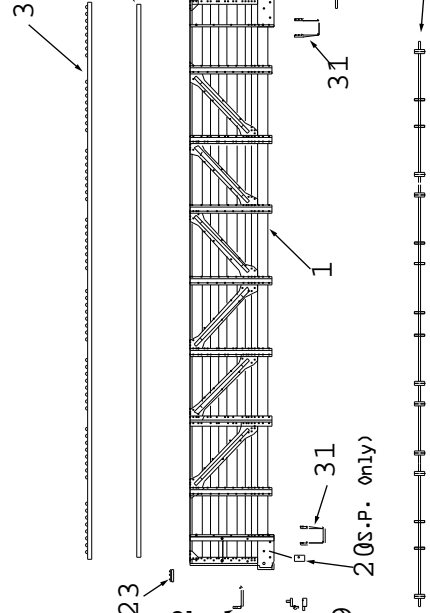
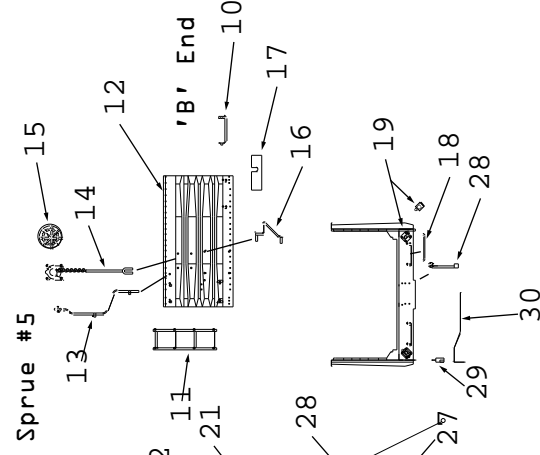

'A' End

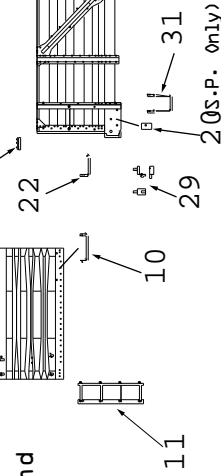

End Rod Mechanism Handles

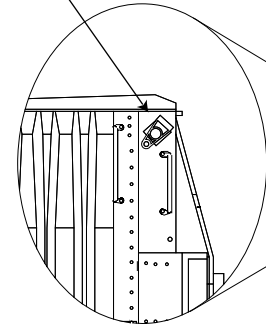

'B' End

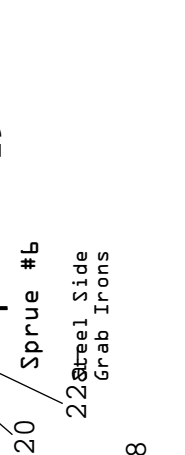

'A' End

35, 36 & 37

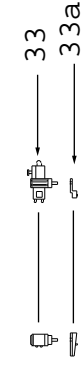
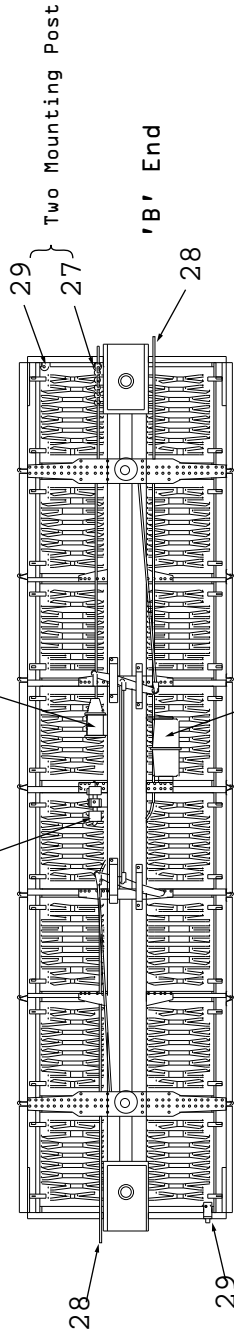

Cut Bottom Off Clevis

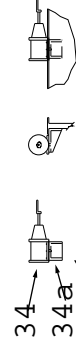

Air Reservoir Brackets

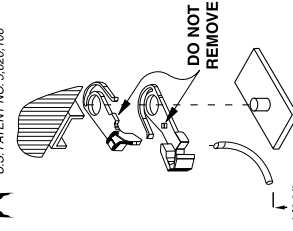

LUBRICATE WITH DRY TEFLON OR GRAPHITE

RED CABOOSE